

dazzle[®]
the ultimate choice

bathroom
| accessories



AN ISO 9001:2008
COMPANY

AISI 304 STAINLESS STEEL



PRODUCT
CATALOGUE **2022**
July



A Decade of Dazzling performance

Over a decade of designing your day with the finest elements of privilege, our history speaks a lot about performing without a pause. Spearheaded by visionary founders and professionally managed by a team of topnotch performers, Perdiem Industries has remained at the forefront of innovation in bathroom accessories and furnishings. Accredited with ISO 9001:2008 (TUV) Quality Certification, we have won not just market share but also hearts of our loyal customers. Today, Perdiem Industries has achieved a thought-leader's position in manufacturing, supplying and exporting superlative products made of high quality SS 304 that meets the highest levels of quality, beauty and durability.

Spread across 2100 Sq. Mt. of area, our production set-up is harnessed with an array of automatic, semi-automatic and manual equipments along with an in-house testing and R&D facility. From design to delivery, we follow the best practices and maintain the focus over ultimate quality and best value-for-money for our clientele. With an installed capacity that is scalable, today, our daily production of 200 sets of bathroom accessories and 2000 pieces of handles is the supply of satisfaction for those who demand only the best.

Today, the brand Dazzle has won accolades not just in India but also beyond its borders. Thanks to a dazzling performance that is a balanced mix of innovation, excellence and perseverance, we have continued to grow as one of the most preferred brand in its category.

Start dazzling your day!

Index



regent



04

eureka



06

orlov



08

creator



12

allanta



14

fortune



16

peridot



20

hope



22

martin



24

cross



26

emerald



28

sapphire



30

arma



32

zircon



34

coral

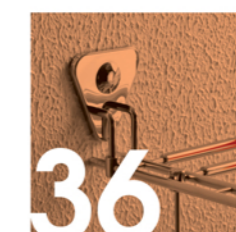

36

opal



38

ruby



40

shelf



42

a member of
TPC Trade Promotion
 Council of India

AISI 304 STAINLESS STEEL



CHROME FINISH

regent

Legal in appearance and robust in its capacity this is a style that is born out of continuous design innovation.

Towel Rack with Rod

Code	DG-1004 [24"]	DG-1005 [18"]
MRP	3530.00	3275.00

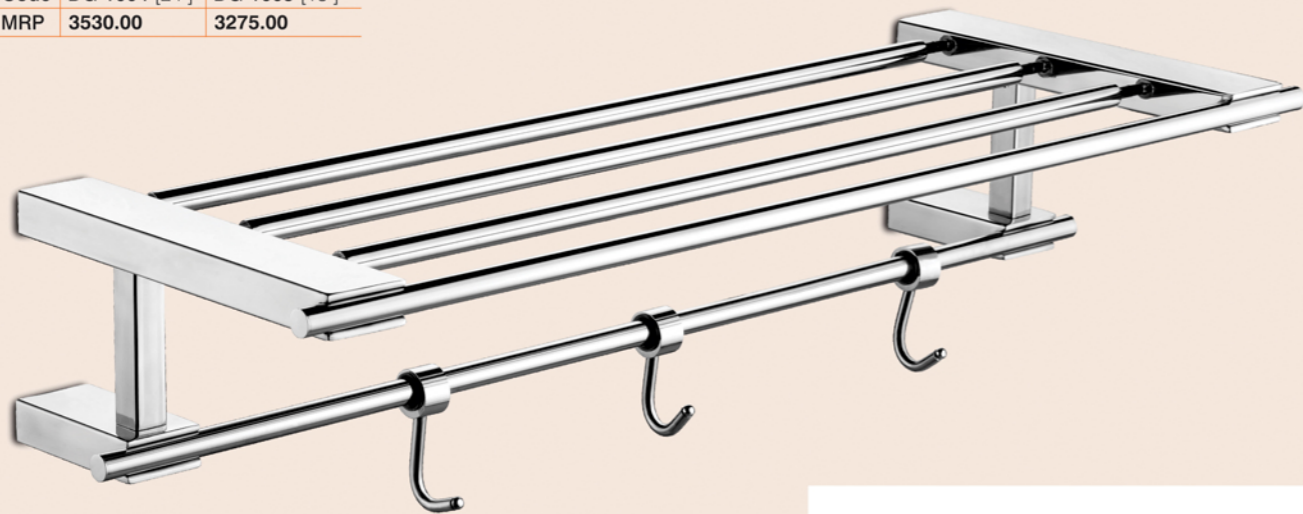

Soap Dish

Code	DG-1008
MRP	840.00



5 Pcs. Set

Code	DG-1001
MRP	4370.00

Towel Rod - Soap Dish
Toothbrush Tumbler
Napkin Holder - Robe Hook

Double Soap Dish

Code	DG-1015
MRP	1175.00



Paper Holder

Code	DG-1014
MRP	1280.00



Soap Dish & Toothbrush Tumbler

Code	DG-1017
MRP	1510.00

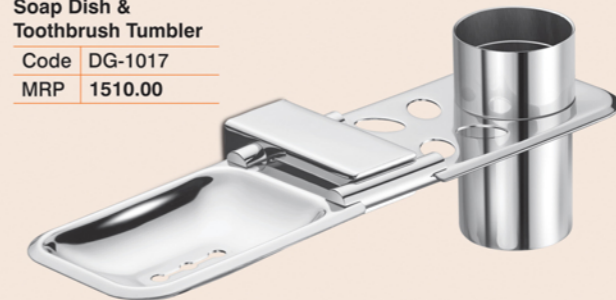

Liquid Soap Dispenser

Code	DG-1013
MRP	1310.00



Robe Hook

Code	DG-1011
MRP	355.00

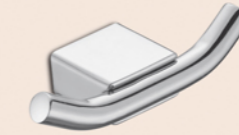

Napkin Holder

Code	DG-1010
MRP	705.00

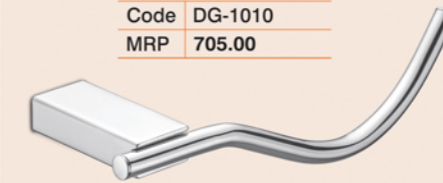

Toothbrush Tumbler

Code	DG-1009
MRP	1125.00



Towel Rod

Code	DG-1006 [24"]	DG-1007 [18"]
MRP	1345.00	1260.00

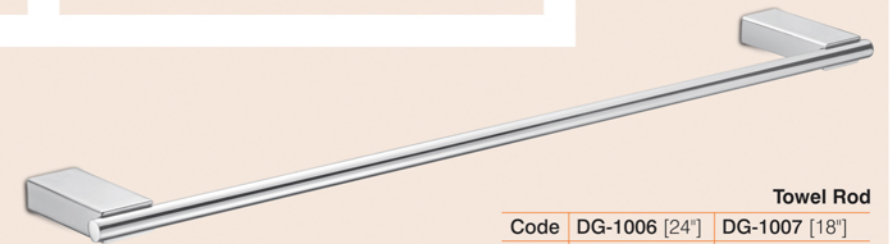



GLOSSY FINISH



Eureka moment is when you hit upon the abundance of style, sophistication and sheer awesomeness. Cherish your intimate moments now in constant wonder.

Towel Rack with Rod

Code	DG-1104 [24"]	DG-1105 [18"]
MRP	2690.00	22435.00

* Hook Charges Extra - Rs. 250.00 (3 Hook)

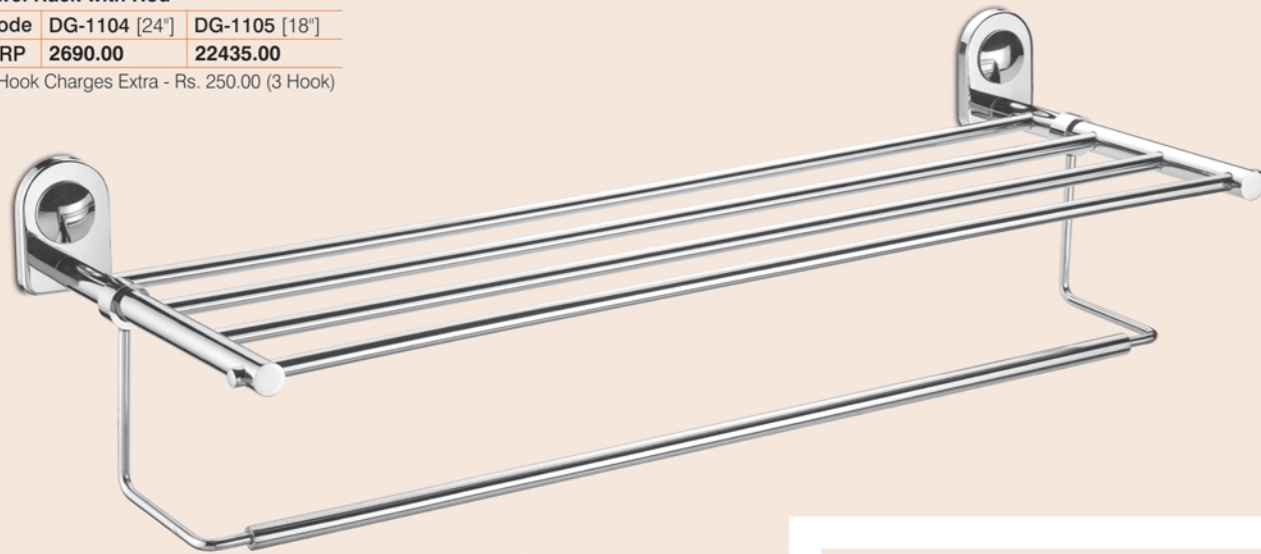

Soap Dish

Code	DG-1108
MRP	370.00



5 Pcs. Set

Code	DG-1101
MRP	2520.00

Towel Rod - Soap Dish
Toothbrush Tumbler
Napkin Holder - Robe Hook

Double Towel Rod

Code	DG-1106 D [24"]
MRP	1680.00

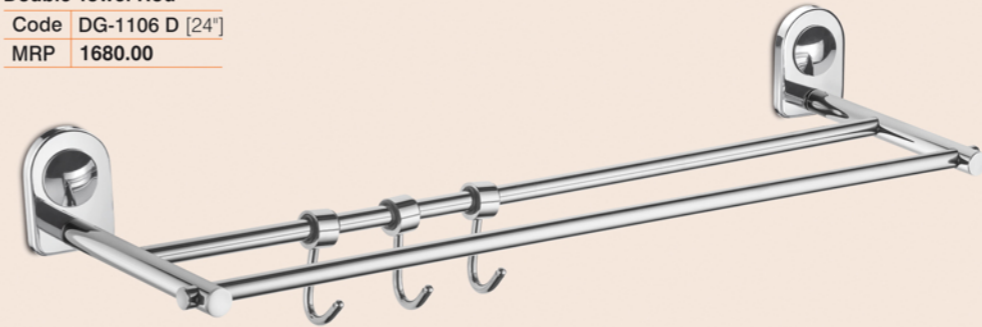

Paper Holder

Code	DG-1114
MRP	840.00



Towel Rod

Code	DG-1106 [24"]	DG-1107 [18"]
MRP	840.00	790.00

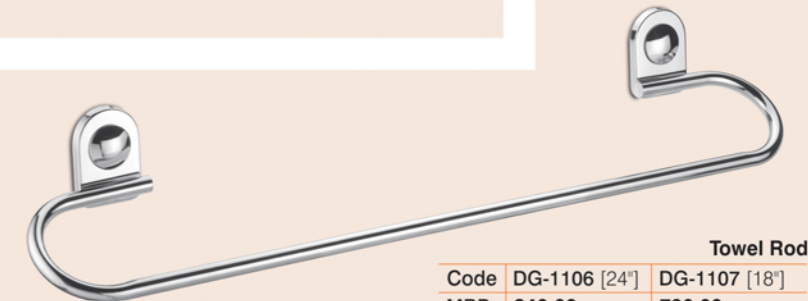

Liquid Soap Dispenser

Code	DG-1113
MRP	790.00

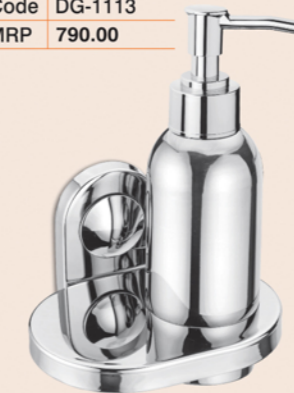

Napkin Holder

Code	DG-1110
MRP	435.00

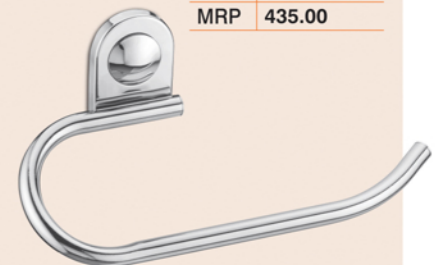

Soap Dish & Toothbrush Tumbler

Code	DG-1117
MRP	910.00



Robe Hook

Code	DG-1111
MRP	270.00



Toothbrush Tumbler

Code	DG-1109
MRP	605.00



Double Soap Dish

Code	DG-1115
MRP	640.00



BRASS +
AISI 304 STAINLESS STEEL



CHROME FINISH



Ordinary of the world will be standing no chance, henceforth. Usher in the new star of style that will speak about its extraordinary presence very effortlessly.

Towel Rack with Rod

Code	DG-1204 [24"]	DG-1205 [18"]
MRP	4450.00	4115.00

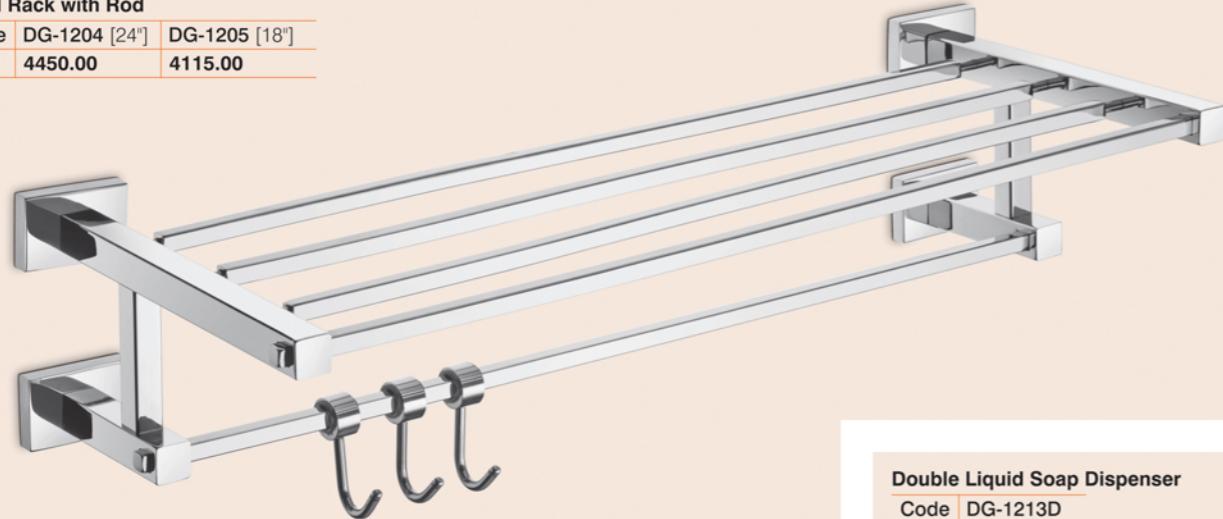

Soap Dish

Code	DG-1208
MRP	925.00

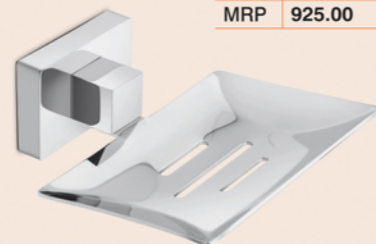

Double Liquid Soap Dispenser

Code	DG-1213D
MRP	2150.00



5 Pcs. Set

Code	DG-1201
MRP	5040.00

Towel Rod - Soap Dish
Toothbrush Tumbler
Napkin Holder - Robe Hook

Double Towel Rod

Code	DG-1206 D [24"]
MRP	2435.00

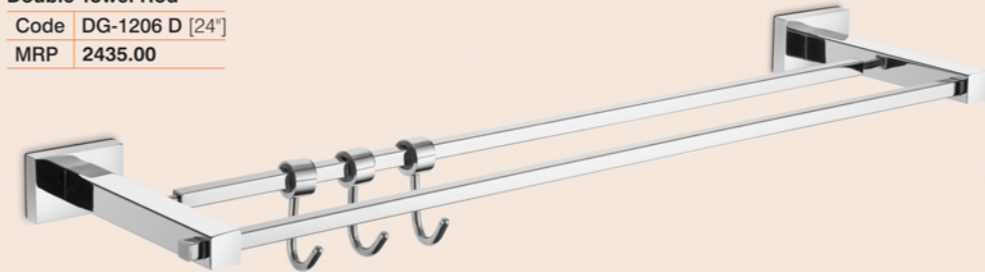

Robe Hook

Code	DG-1211
MRP	755.00



Liquid Soap Dispenser

Code	DG-1213
MRP	1545.00

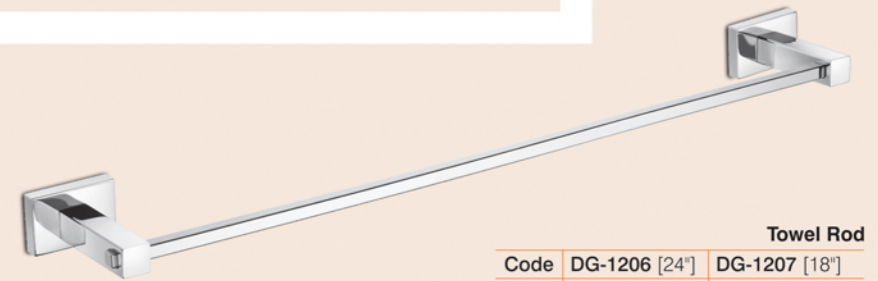

Towel Rod

Code	DG-1206 [24"]	DG-1207 [18"]
MRP	1310.00	1225.00

Napkin Holder

Code	DG-1210
MRP	840.00

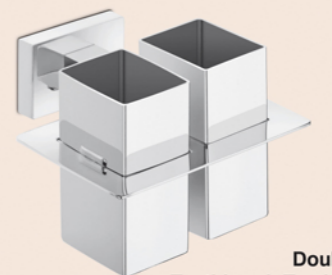
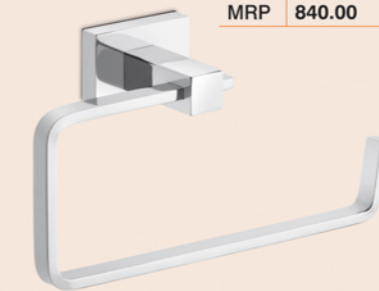

Double Toothbrush Tumbler

Code	DG-1209D
MRP	1480.00

Toothbrush Tumbler

Code	DG-1209
MRP	1210.00



Paper Holder

Code	DG-1214
MRP	1345.00



Double Soap Dish

Code	DG-1215
MRP	1380.00

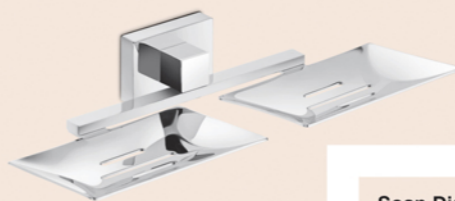

Soap Dish & Toothbrush Tumbler

Code	DG-1217
MRP	1765.00



BLACK PVD FINISH

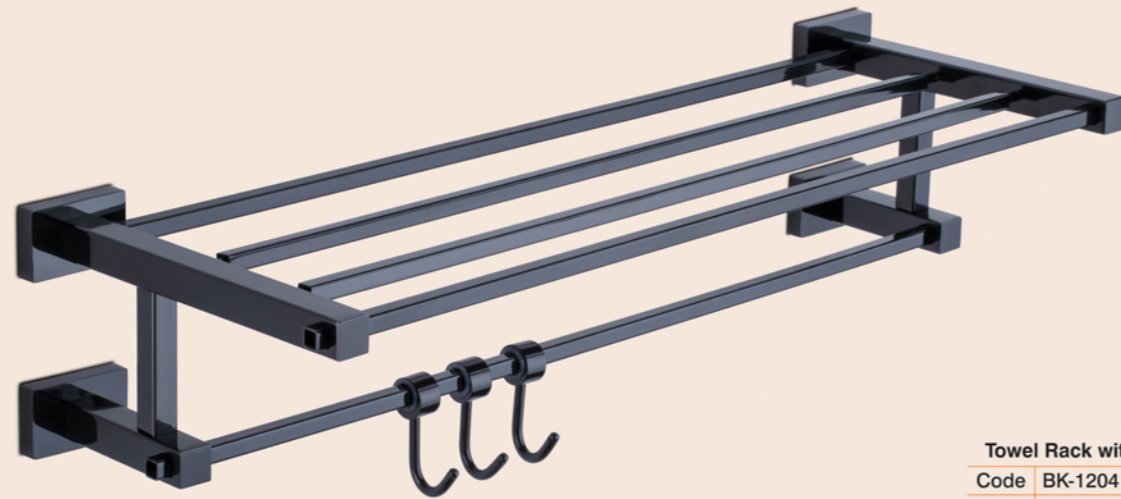

Towel Rack with Rod
Code BK-1204 [24"]
MRP 8265.00

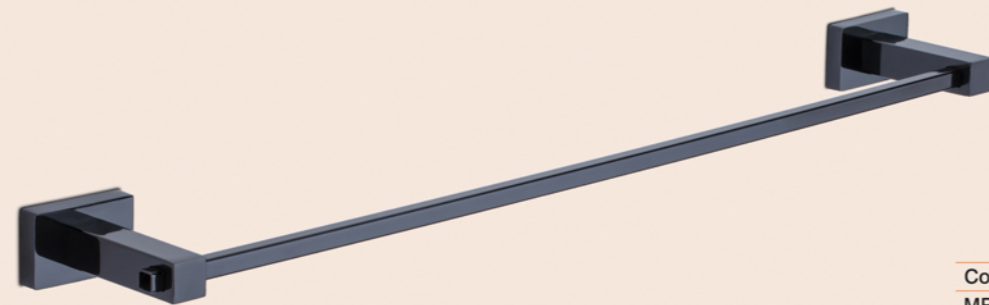

Towel Rod
Code BK-1206 [24"]
MRP 2220.00

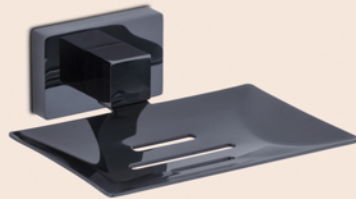

Soap Dish
Code BK-1208
MRP 1450.00



Toothbrush Tumbler
Code BK-1209
MRP 2000.00

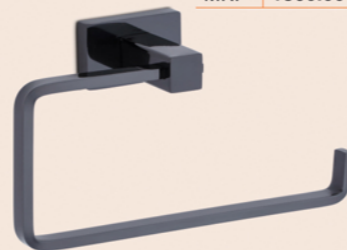

Napkin Holder
Code BK-1210
MRP 1360.00

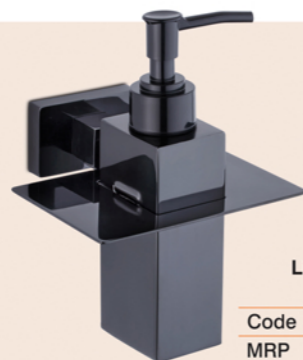

Liquid Soap Dispenser
Code BK-1213
MRP 2555.00



Paper Holder
Code BK-1214
MRP 2250.00

5 Pcs. Set
Code BK-1201
MRP 8100.00
Towel Rod - Soap Dish
Toothbrush Tumbler
Napkin Holder - Robe Hook

ROSE GOLD PVD FINISH



Towel Rack with Rod
Code RG-1204 [24"]
MRP 8265.00

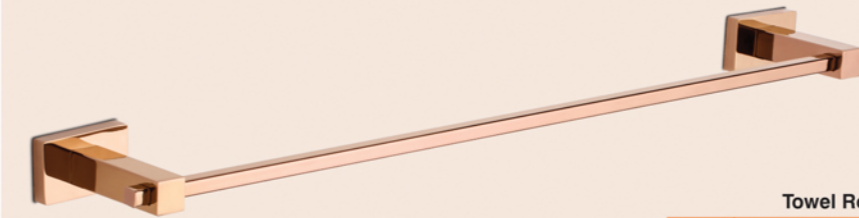

Towel Rod
Code RG-1206 [24"]
MRP 2220.00

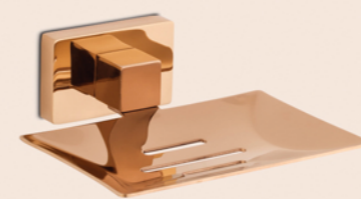

Soap Dish
Code RG-1208
MRP 1450.00

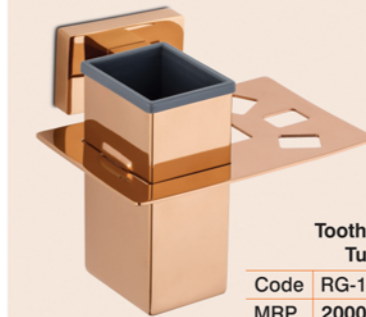

Toothbrush Tumbler
Code RG-1209
MRP 2000.00

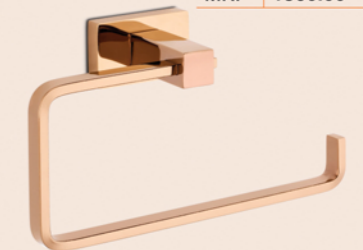

Napkin Holder
Code RG-1210
MRP 1360.00



Paper Holder
Code RG-1214
MRP 2250.00

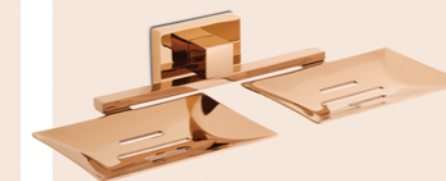

Double Soap Dish
Code RG-1215
MRP 2485.00



Soap Dish & Toothbrush Tumbler
Code RG-1217
MRP 3100.00

5 Pcs. Set
Code RG-1201
MRP 8100.00
Towel Rod - Soap Dish
Toothbrush Tumbler
Napkin Holder - Robe Hook



Robe Hook
Code RG-1211
MRP 1065.00

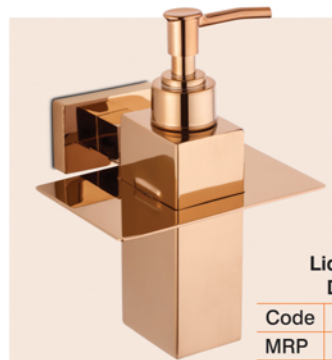

Liquid Soap Dispenser
Code RG-1213
MRP 2555.00



BRASS +
AISI 304 STAINLESS STEEL



CHROME FINISH



creator

Chances are you will find it only in the most important places. The true gem of grand design and impeccable aesthetics, this range is made for those who afford the highest norms of status.

Towel Rack with Rod

Code DG-1304 [24"]
MRP 5375.00

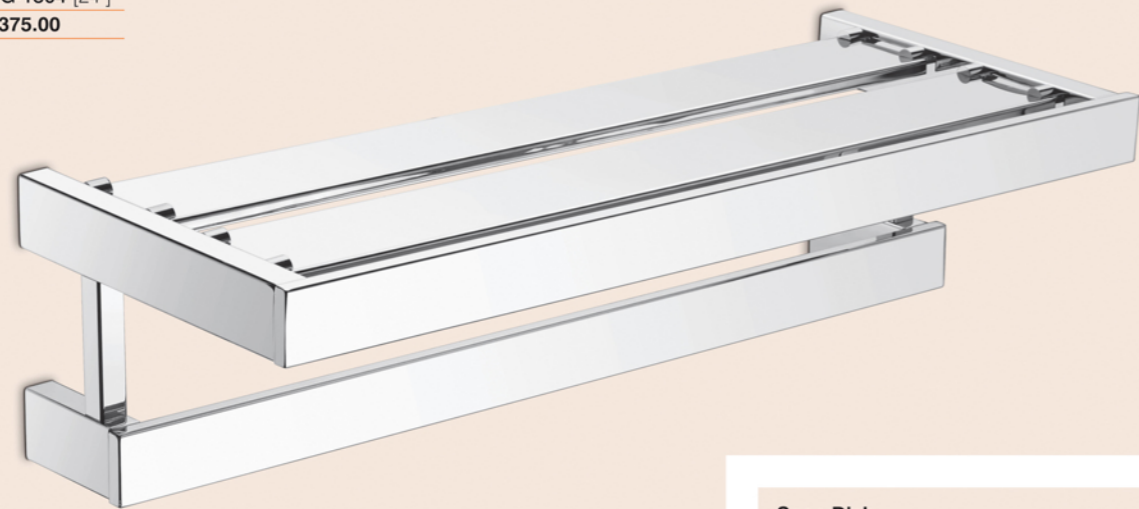

5 Pcs. Set
Code DG-1301
MRP 5710.00

Towel Rod - Soap Dish
Toothbrush Tumbler
Napkin Holder
Robe Hook

Napkin Holder

Code DG-1310
MRP 875.00



Soap Dish

Code DG-1308
MRP 1125.00



Double Soap Dish

Code DG-1315
MRP 1980.00

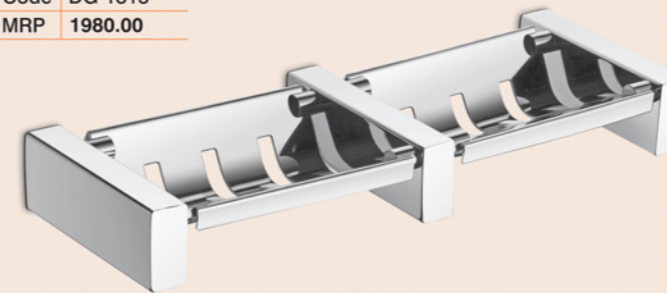

Soap Dish & Toothbrush Tumbler

Code DG-1317
MRP 2235.00

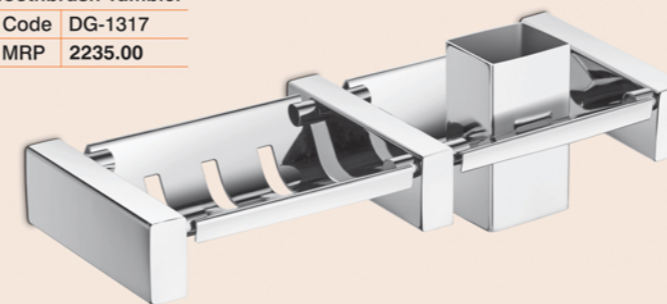

Robe Hook

Code DG-1311
MRP 385.00



Toothbrush Tumbler

Code DG-1309
MRP 1360.00



Towel Rod

Code DG-1306 [24"]
MRP 1980.00

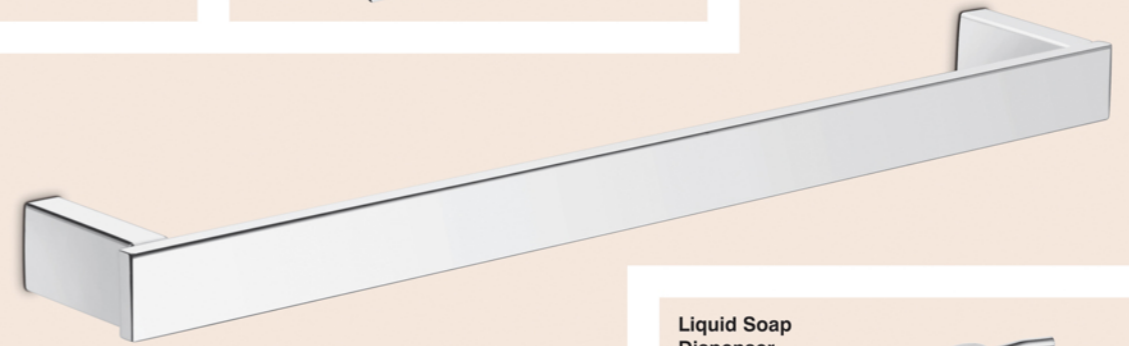

Liquid Soap Dispenser

Code DG-1313
MRP 1745.00



Paper Holder

Code DG-1314
MRP 620.00



BRASS +
AISI 304 STAINLESS STEEL

allanta

CHROME FINISH

Algorithm of exquisite looks that comes pre-loaded with avant-garde design is here to impress the world in an instant.

Towel Rack with Rod

Code	DG-1404 [24"]	DG-1405 [18"]
MRP	4115.00	3865.00

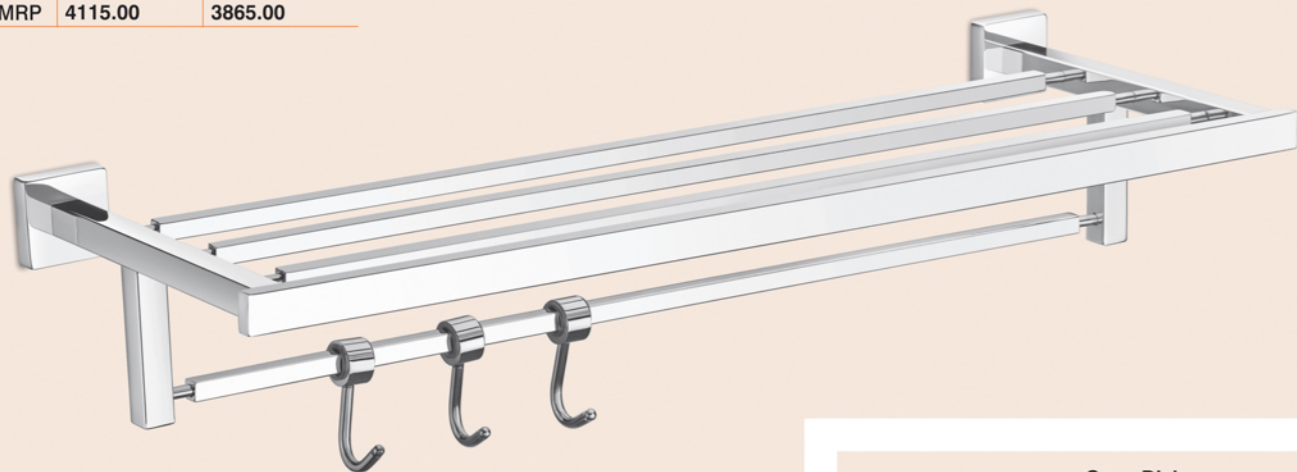

5 Pcs. Set

Code	DG-1401
MRP	4920.00

- Towel Rod
- Soap Dish
- Toothbrush Tumbler
- Napkin Holder
- Robe Hook

Robe Hook

Code	DG-1411
MRP	670.00



Soap Dish

Code	DG-1408
MRP	925.00



Towel Rod

Code	DG-1406 [24"]	DG-1407 [18"]
MRP	1430.00	1345.00



Soap Dish & Toothbrush Tumbler

Code	DG-1417
MRP	1515.00



Double Soap Dish

Code	DG-1415
MRP	1380.00



Napkin Holder

Code	DG-1410
MRP	840.00



Soap Dish (Glass)

Code	DG-1408G
MRP	1090.00



Paper Holder

Code	DG-1414
MRP	1345.00



Toothbrush Tumbler

Code	DG-1409
MRP	1060.00



Liquid Soap Dispenser

Code	DG-1413
MRP	1430.00





BRASS +
AISI 304 STAINLESS STEEL

CHROME FINISH

 **fortune**

furbish of a different kind that is specially crafted for your personal space to signify your distinguished urban lifestyle.

Towel Rack with Rod

Code	DG-1504 [24"]	DG-1505 [18"]
MRP	3530.00	3275.00

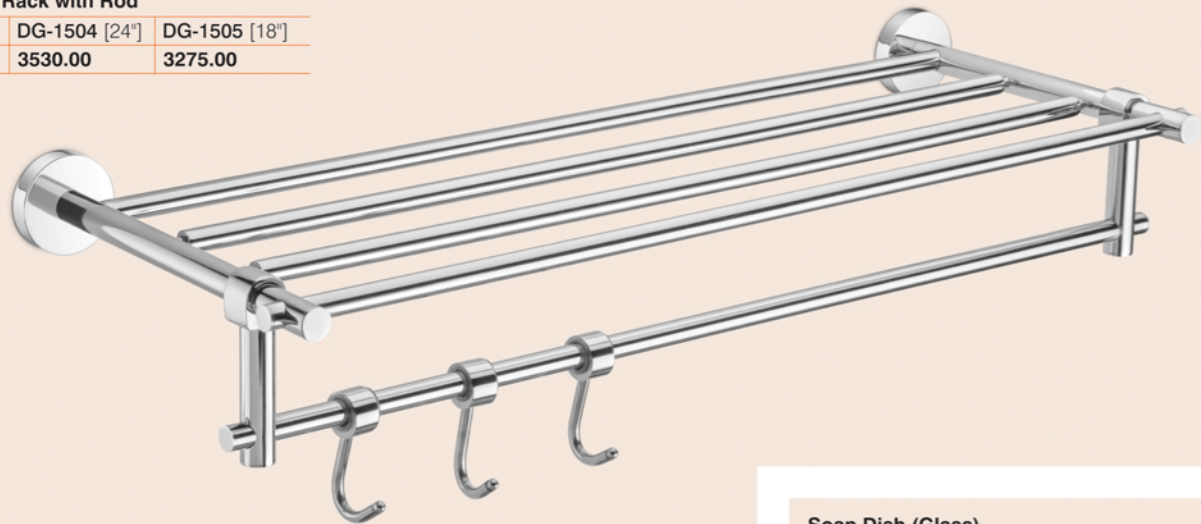

5 Pcs. Set	
Code	DG-1501
MRP	4285.00

- Towel Rod
- Soap Dish
- Toothbrush Tumbler
- Napkin Holder
- Robe Hook

Soap Dish

Code	DG-1508
MRP	840.00



Soap Dish (Glass)

Code	DG-1508G
MRP	740.00



Double Towel Rod

Code	DG-1506 D [24"]
MRP	2200.00

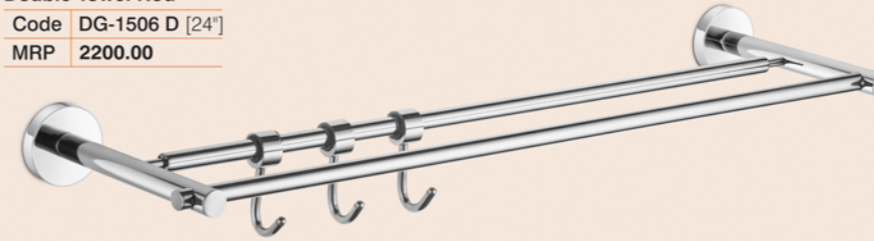

Towel Rod

Code	DG-1506 [24"]	DG-1507 [18"]
MRP	1195.00	1125.00



Robe Hook

Code	DG-1511
MRP	505.00

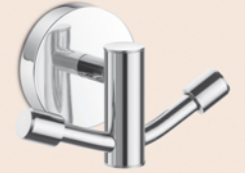

Napkin Holder

Code	DG-1510
MRP	740.00



Toothbrush Tumbler

Code	DG-1509
MRP	1010.00



Liquid Soap Dispenser (Glass)

Code	DG-1513G
MRP	925.00



Toothbrush Tumbler (Glass)

Code	DG-1509G
MRP	805.00



Double Soap Dish

Code	DG-1515
MRP	1430.00



Paper Holder

Code	DG-1514
MRP	1125.00



Soap Dish & Toothbrush Tumbler

Code	DG-1517
MRP	1595.00



BLACK PVD FINISH

fortune



Towel Rack with Rod
Code BK-1504 [24"]
MRP 6750.00



Towel Rod
Code BK-1506 [24"]
MRP 2100.00



Robe Hook
Code BK-1511
MRP 805.00



Soap Dish
Code BK-1508
MRP 1360.00



Toothbrush Tumbler
Code BK-1509
MRP 1795.00



Napkin Holder
Code BK-1510
MRP 1260.00

Towel Rod - Soap Dish
Toothbrush Tumbler
Napkin Holder - Robe Hook

5 Pcs. Set
Code BK-1501
MRP 7325.00



Double Soap Dish
Code BK-1515
MRP 2520.00



Toothbrush Tumbler (Glass)
Code BK-1509G
MRP 1110.00

ROSE GOLD PVD FINISH

fortune

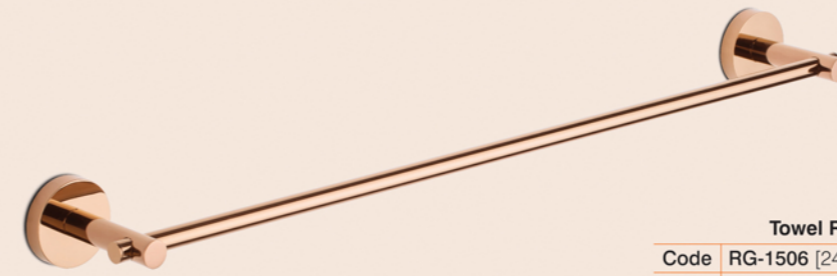

Towel Rod
Code RG-1506 [24"]
MRP 2100.00

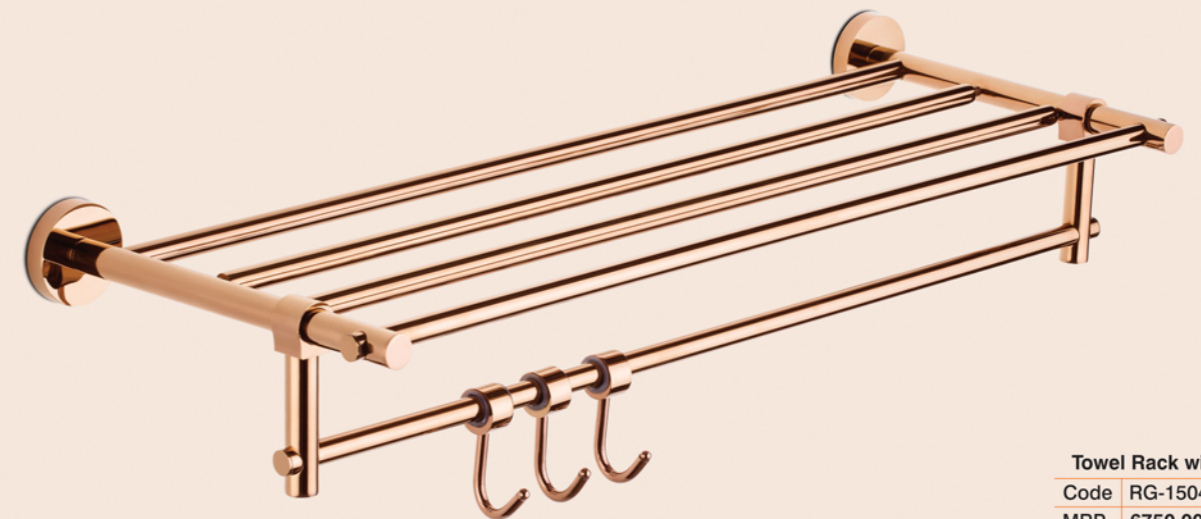

Towel Rack with Rod
Code RG-1504 [24"]
MRP 6750.00



Soap Dish
Code RG-1508
MRP 1360.00



Toothbrush Tumbler
Code RG-1509
MRP 1795.00



Napkin Holder
Code RG-1510
MRP 1260.00

Soap Dish (Glass)
Code RG-1508G
MRP 1040.00

Liquid Soap Dispenser (Glass)
Code RG-1513G
MRP 1225.00



Paper Holder
Code RG-1514
MRP 2030.00



Soap Dish & Toothbrush Tumbler
Code RG-1517
MRP 2890.00

5 Pcs. Set
Code RG-1501
MRP 7325.00
Towel Rod - Soap Dish
Toothbrush Tumbler
Napkin Holder - Robe Hook

BRASS +
AISI 304 STAINLESS STEEL

**BRASS +
AISI 304 STAINLESS STEEL**



CHROME FINISH

peridot

Perfection cannot be improved upon, this spectacularly smart design was born to prove you wrong.

Towel Rack with Rod

Code	DG-1604 [24"]	DG-1605 [18"]
MRP	4115.00	3865.00

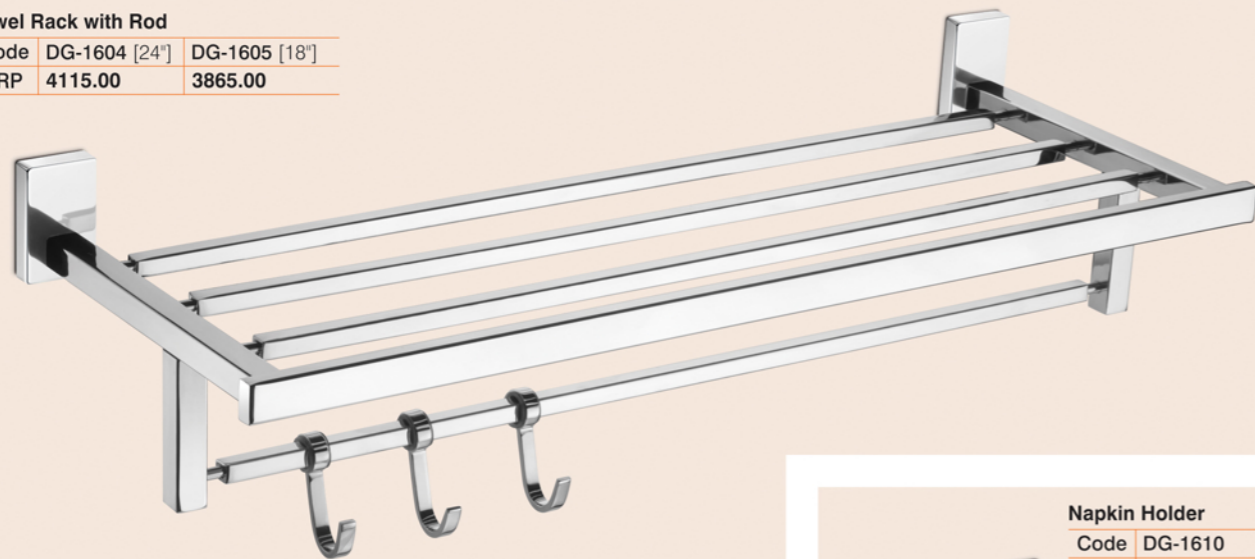

5 Pcs. Set

Code	DG-1601
MRP	4705.00

- Towel Rod
- Soap Dish
- Toothbrush Tumbler
- Napkin Holder
- Robe Hook

Soap Dish (Glass)

Code	DG-1608G
MRP	960.00



Napkin Holder

Code	DG-1610
MRP	840.00



dazzie
the ultimate choice

Robe Hook

Code	DG-1611
MRP	555.00



Soap Dish (PTMT)

Code	DG-1608A
MRP	840.00



Liquid Soap Dispenser (PTMT)

Code	DG-1613A
MRP	1380.00



Liquid Soap Dispenser (Glass)

Code	DG-1613G
MRP	1430.00



Towel Rod

Code	DG-1606 [24"]	DG-1607 [18"]
MRP	1430.00	1345.00

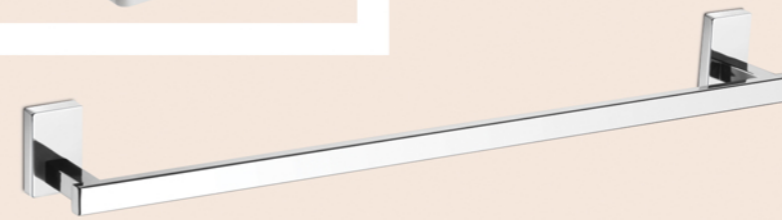

Toothbrush Tumbler (Glass)

Code	DG-1609G
MRP	925.00



Paper Holder with Mobile Stand

Code	DG-1614
MRP	1480.00

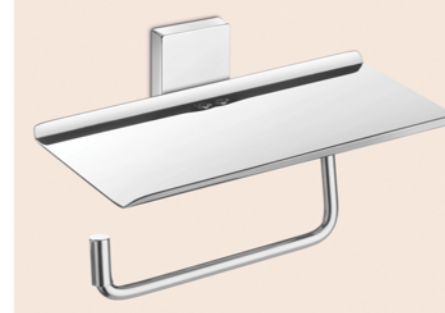

Toothbrush Tumbler & Liquid Soap Dispenser (PTMT)

Code	DG-1618A
MRP	1650.00



Toothbrush Tumbler (PTMT)

Code	DG-1609A
MRP	875.00



Double Soap Dish (PTMT)

Code	DG-1615A
MRP	1175.00



Soap Dish & Toothbrush Tumbler (PTMT)

Code	DG-1617A
MRP	1210.00





GLOSSY FINISH



hey, turn a mundane day into a story of magic realism with this metaphor of style exclusively made for you.

Towel Rack with Rod

Code	DG-1704 [24"]	DG-1705 [18"]
MRP	2770.00	2485.00

* Hook Charges Extra - Rs. 250.00 (3 Hook)

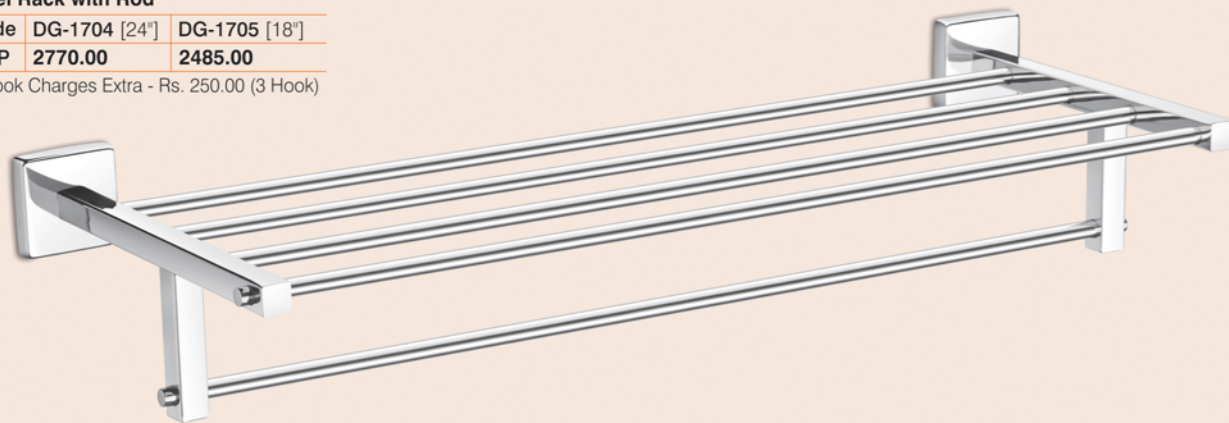

Robe Hook

Code	DG-1711
MRP	355.00

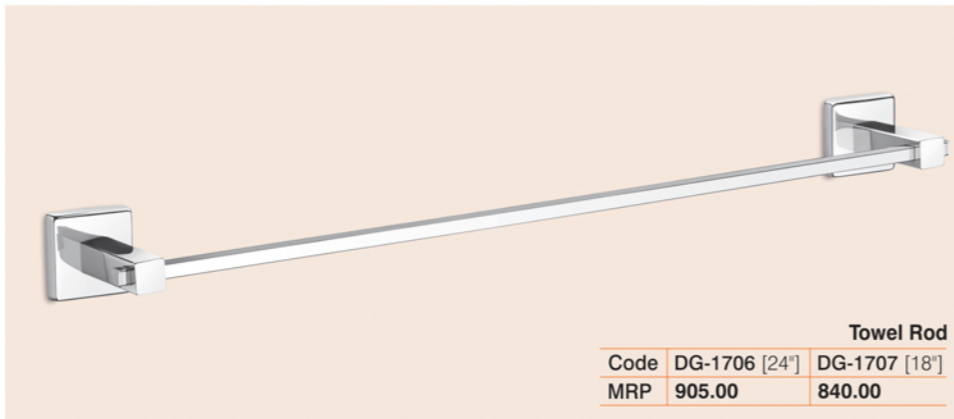

Towel Rod

Code	DG-1706 [24"]	DG-1707 [18"]
MRP	905.00	840.00

Soap Dish & Toothbrush Tumbler (PTMT)
Code DG-1717
MRP 605.00

Toothbrush Tumbler & Liquid Soap Dispenser (PTMT)
Code DG-1718
MRP 1040.00

Napkin Holder
Code DG-1710
MRP 620.00

Paper Holder
Code DG-1714
MRP 940.00

Double Soap Dish (PTMT)
Code DG-1715
MRP 570.00

Soap Dish (PTMT)
Code DG-1708
MRP 300.00

Soap Dish (PTMT)
Code TT-08
MRP 435.00

Soap Dish (Glass)
Code TT-08G
MRP 620.00

TABLE TOP ACCESSORIES

Toothbrush Tumbler (PTMT)
Code DG-1709
MRP 370.00

Toothbrush Tumbler (PTMT)
Code TT-09
MRP 700.00

Toothbrush Tumbler (Glass)
Code TT-09G
MRP 740.00

Liquid Soap Dispenser (PTMT)
Code DG-1713
MRP 740.00

Liquid Soap Dispenser (PTMT)
Code TT-13
MRP 1060.00

Liquid Soap Dispenser (Glass)
Code TT-13G
MRP 1100.00



GLOSSY FINISH



Majestic in appearance and robust in its capacity this is a style that is born out of continuous design innovation.

Towel Rack with Rod

Code	DG-1804 [24"]	DG-1805 [18"]
MRP	2690.00	2435.00

* Hook Charges Extra - Rs. 250.00 (3 Hook)

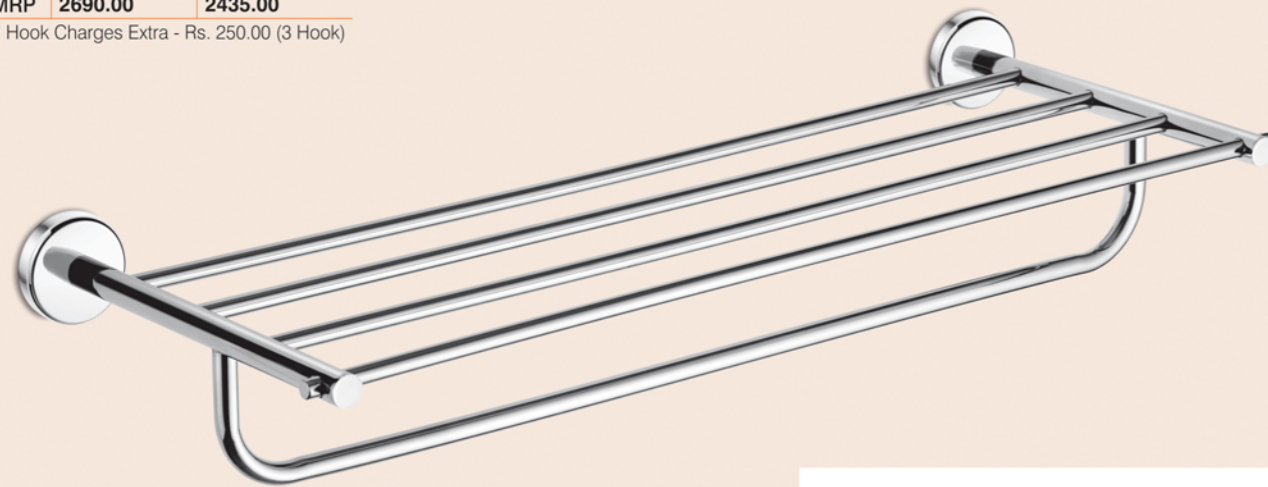

Soap Dish

Code	DG-1808
MRP	505.00



5 Pcs. Set

Code	DG-1801
MRP	2940.00

Towel Rod - Soap Dish
Toothbrush Tumbler
Napkin Holder - Robe Hook

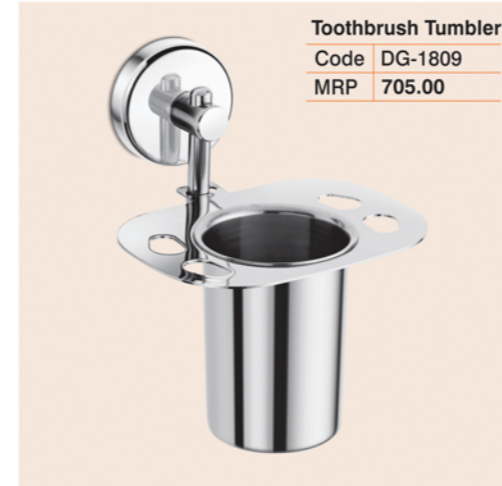

Toothbrush Tumbler
Code DG-1809
MRP 705.00



Napkin Holder
Code DG-1810
MRP 620.00



Robe Hook
Code DG-1811
MRP 270.00



Liquid Soap Dispenser
Code DG-1813G
MRP 670.00

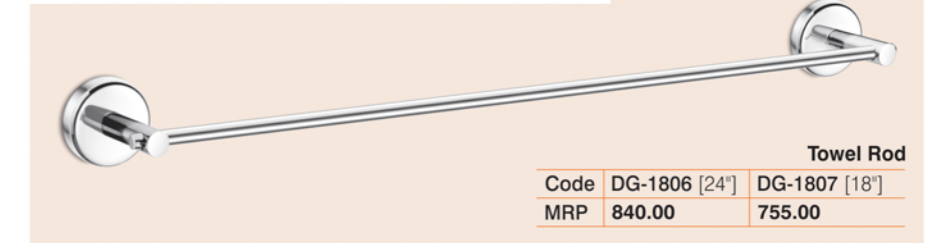

Towel Rod	
Code DG-1806 [24"]	DG-1807 [18"]
MRP 840.00	755.00



Soap Dish & Toothbrush Tumbler
Code DG-1817
MRP 1110.00



Paper Holder
Code DG-1814
MRP 940.00



Double Soap Dish
Code DG-1815
MRP 905.00



GLOSSY FINISH



Climax cannot be improved upon, this spectacularly smart design was born to prove you wrong.

Towel Rack with Rod

Code	DG-1904 [24"]	DG-1905 [18"]
MRP	3025.00	2770.00

* Hook Charges Extra - Rs. 250.00 (3 Hook)

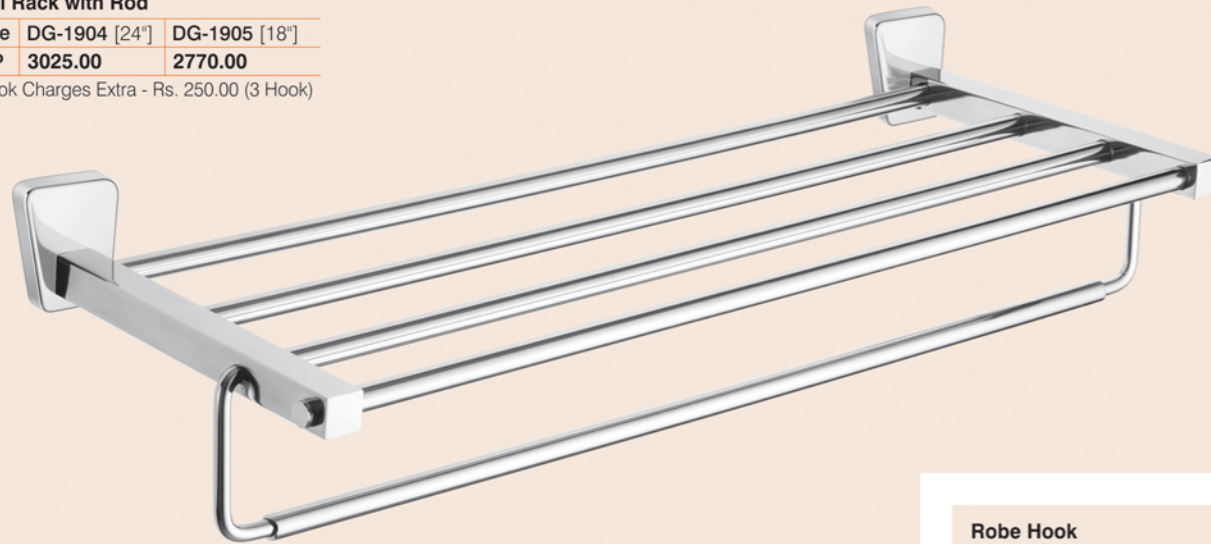

5 Pcs. Set

Code	DG-1901
MRP	3700.00

- Towel Rod
- Soap Dish
- Toothbrush Tumbler
- Napkin Holder
- Robe Hook



Soap Dish

Code	DG-1908
MRP	570.00

Robe Hook

Code	DG-1911
MRP	385.00



Toothbrush Tumbler
Code DG-1909
MRP 755.00



Napkin Holder
Code DG-1910
MRP 840.00

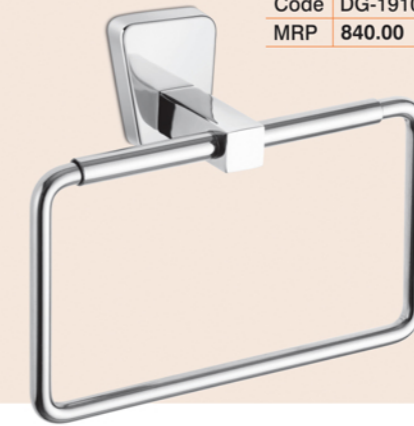

Liquid Soap Dispenser
Code DG-1913
MRP 890.00



Towel Rod
Code DG-1906 [24"] DG-1907 [18"]
MRP 1140.00 1090.00

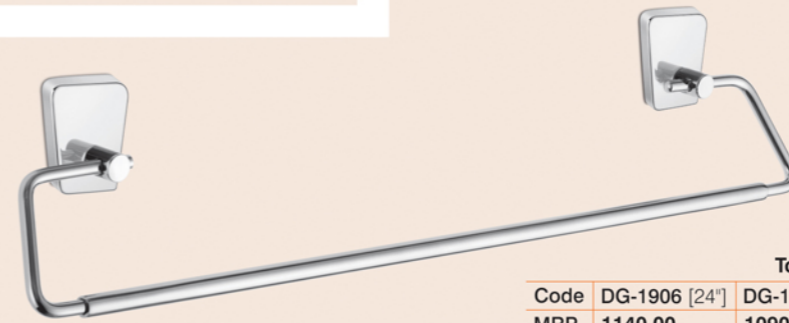

Soap Dish & Toothbrush Tumbler

Code	DG-1917
MRP	1325.00



Double Soap Dish

Code	DG-1915
MRP	1125.00



Paper Holder

Code	DG-1914
MRP	940.00



Toothbrush Tumbler & Liquid Soap Dispenser

Code	DG-1918
MRP	1510.00



Double Soap Dish & Toothbrush Tumbler

Code	DG-1919
MRP	1840.00





GLOSSY FINISH

emerged from the design principles of today's digitally evolved world and ready to woo you – at very first glance.

Towel Rack with Rod

Code	DG-104 [24"]	DG-105 [18"]
MRP	3560.00	3190.00

* Hook Charges Extra - Rs. 250.00 (3 Hook)

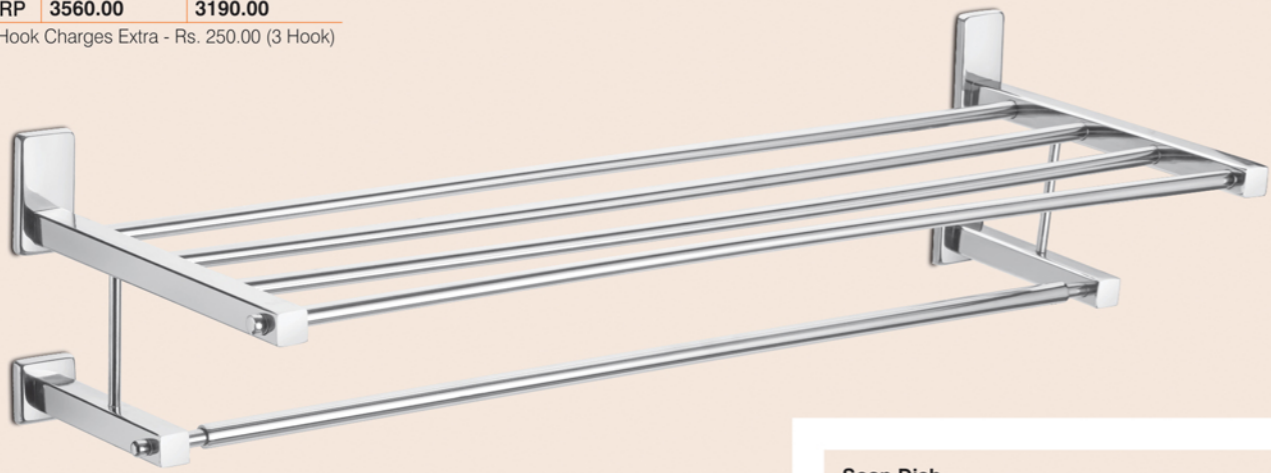

Soap Dish

Code	DG-108
MRP	1060.00



Napkin Holder

Code	DG-110
MRP	705.00



5 Pcs. Set

Code	DG-101
MRP	4570.00

- Towel Rod
- Soap Dish
- Toothbrush Tumbler
- Napkin Holder
- Robe Hook

Paper Holder

Code	DG-114
MRP	1245.00



Liquid Soap Dispenser

Code	DG-113
MRP	1480.00

Toothbrush Tumbler

Code	DG-109
MRP	1445.00

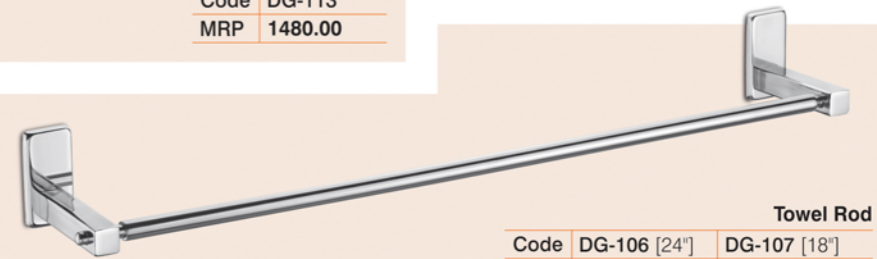
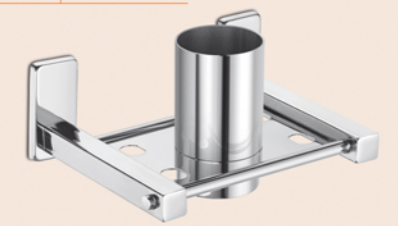

Towel Rod

Code	DG-106 [24"]	DG-107 [18"]
MRP	1090.00	1025.00

Toothbrush Tumbler & Napkin Holder

Code	DG-118
MRP	1530.00

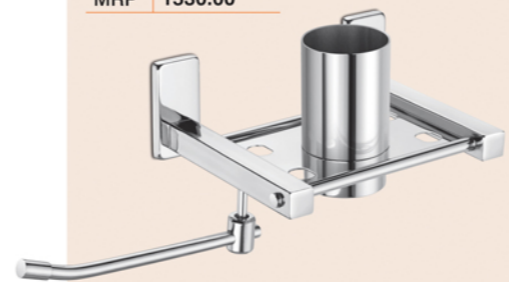

Double Soap Dish

Code	DG-115
MRP	1580.00

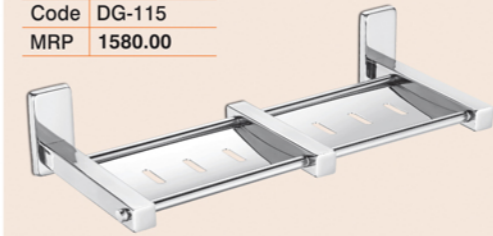

Four in One

Code	DG-122
MRP	3360.00

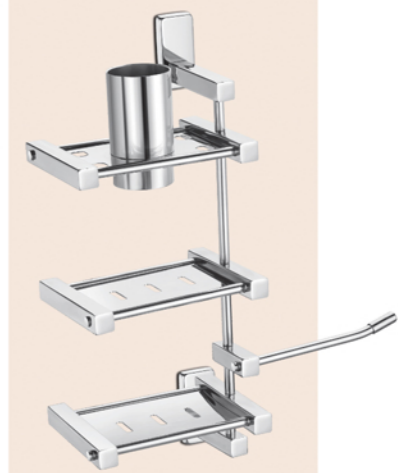

Soap Dish & Toothbrush Tumbler

Code	DG-117
MRP	1915.00



Liquid & Napkin Holder

Code	DG-120
MRP	1880.00

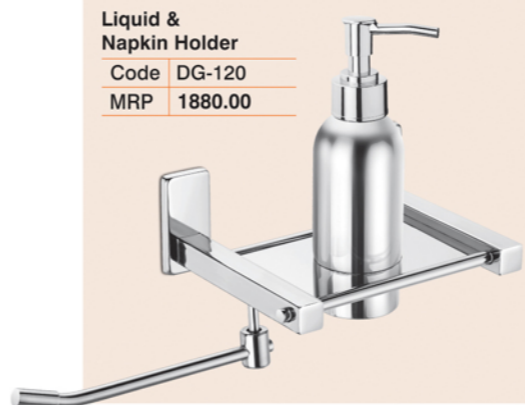

Soap Dish & Napkin Holder

Code	DG-119
MRP	1260.00

Robe Hook

Code	DG-111
MRP	270.00



AISI 304 STAINLESS STEEL



GLOSSY FINISH

sapphire

Sanitation meets style meets serendipity in a spellbinding manner to make you jumpstart the day in an upbeat mood.

Towel Rack with Rod

Code	DG-204 [24"]	DG-205 [18"]
MRP	3520.00	3110.00

* Hook Charges Extra - Rs. 250.00 (3 Hook)

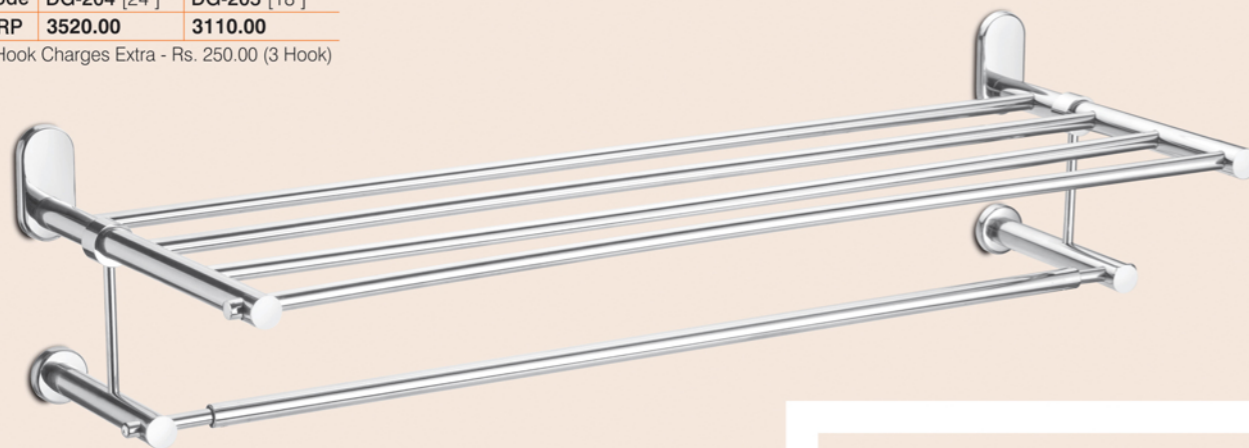

Napkin Holder

Code	DG-210
MRP	840.00



Soap Dish

Code	DG-208
MRP	975.00



5 Pcs. Set

Code	DG-201
MRP	4420.00

- Towel Rod
- Soap Dish
- Toothbrush Tumbler
- Napkin Holder
- Robe Hook

Double Soap Dish

Code	DG-215
MRP	1460.00



Toothbrush Tumbler

Code	DG-209
MRP	1345.00



Soap Dish & Toothbrush Tumbler

Code	DG-217
MRP	1715.00

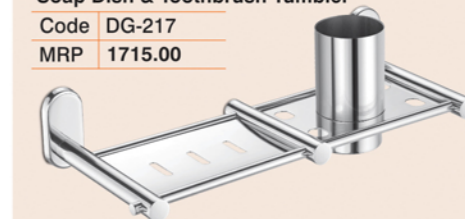

Towel Rod

Code	DG-206 [24"]	DG-207 [18"]
MRP	1025.00	960.00



Paper Holder

Code	DG-214
MRP	1160.00



Toothbrush Tumbler & Napkin Holder

Code	DG-218
MRP	1445.00



Liquid Soap Dispenser

Code	DG-213
MRP	1380.00



Soap Dish & Napkin Holder

Code	DG-219
MRP	1175.00



Three in One

Code	DG-221
MRP	2860.00



Four in One

Code	DG-222
MRP	2960.00

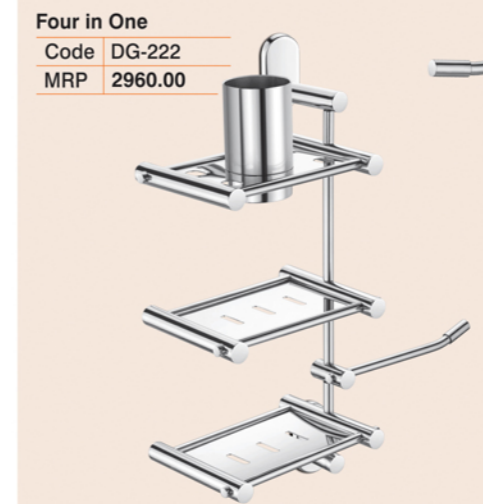

Liquid & Napkin Holder

Code	DG-220
MRP	1700.00

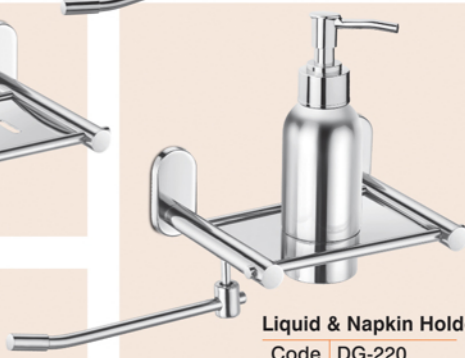

Robe Hook

Code	DG-211
MRP	235.00



AISI 304 STAINLESS STEEL



GLOSSY FINISH



Algorithm of exquisite looks that comes pre-loaded with avant-garde design is here to impress the world in an instant.

Towel Rack with Rod

Code	DG-304 [24"]	DG-305 [18"]
MRP	2775.00	2470.00

* Hook Charges Extra - Rs. 250.00 (3 Hook)

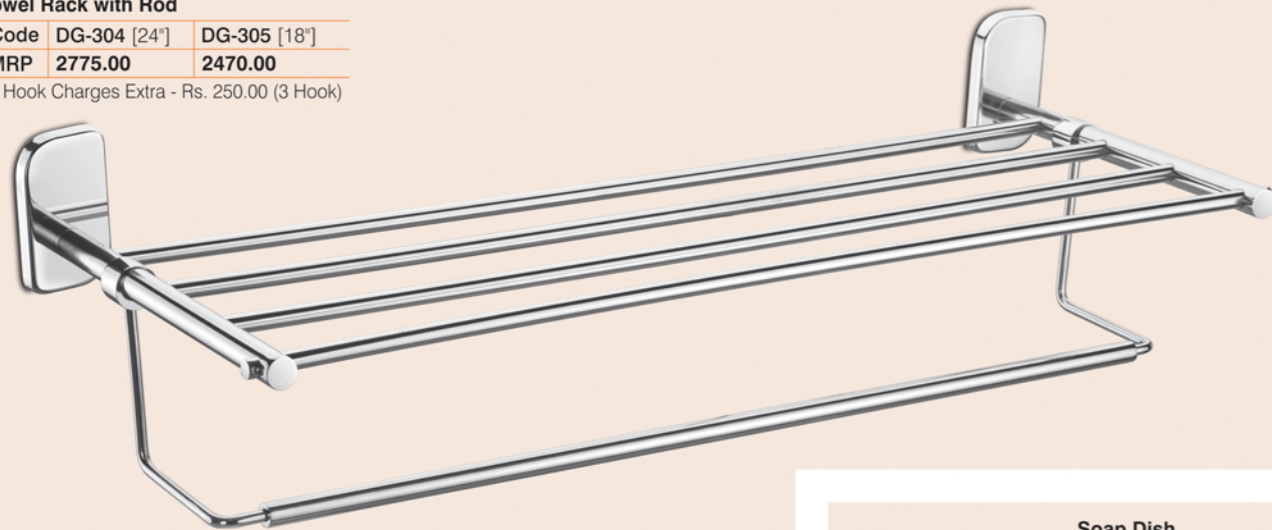

Soap Dish

Code	DG-308
MRP	470.00



5 Pcs. Set

Code	DG-301
MRP	3330.00

Towel Rod
Soap Dish
Toothbrush Tumbler
Napkin Holder
Robe Hook

Towel Rod

Code	DG-306 [24"]	DG-307 [18"]
MRP	1110.00	1045.00

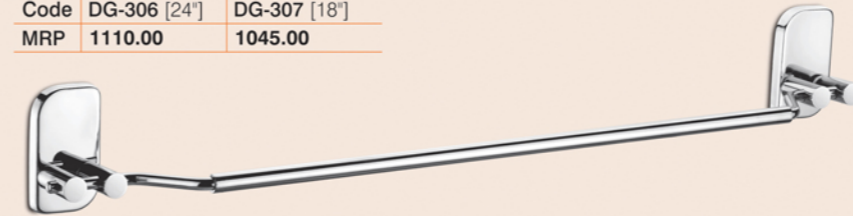

Soap Dish & Toothbrush Tumbler

Code	DG-317
MRP	1175.00



Double Soap Dish

Code	DG-315
MRP	875.00

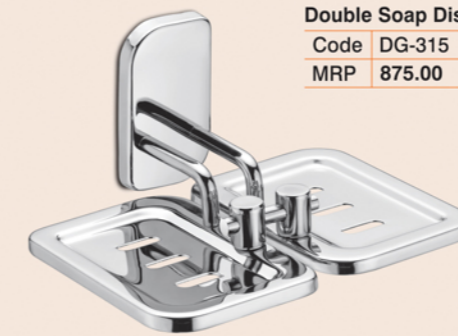

Napkin Holder

Code	DG-310
MRP	705.00



Robe Hook

Code	DG-311
MRP	270.00



Paper Holder

Code	DG-314
MRP	940.00



Toothbrush Tumbler

Code	DG-309
MRP	775.00



Liquid Soap Dispenser

Code	DG-313
MRP	940.00



AISI 304 STAINLESS STEEL



GLOSSY FINISH



Zen philosophy of minimalism got its new definition when we designed this sleek & shiny yet solid statements in steel.

Toothbrush Tumbler

Code DG-409
MRP 1075.00

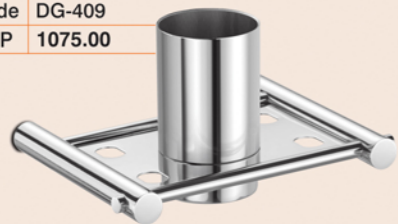

Towel Rack with Rod

Code DG-404 [24"] DG-405 [18"]
MRP 3260.00 2875.00

* Hook Charges Extra - Rs. 250.00 (3 Hook)

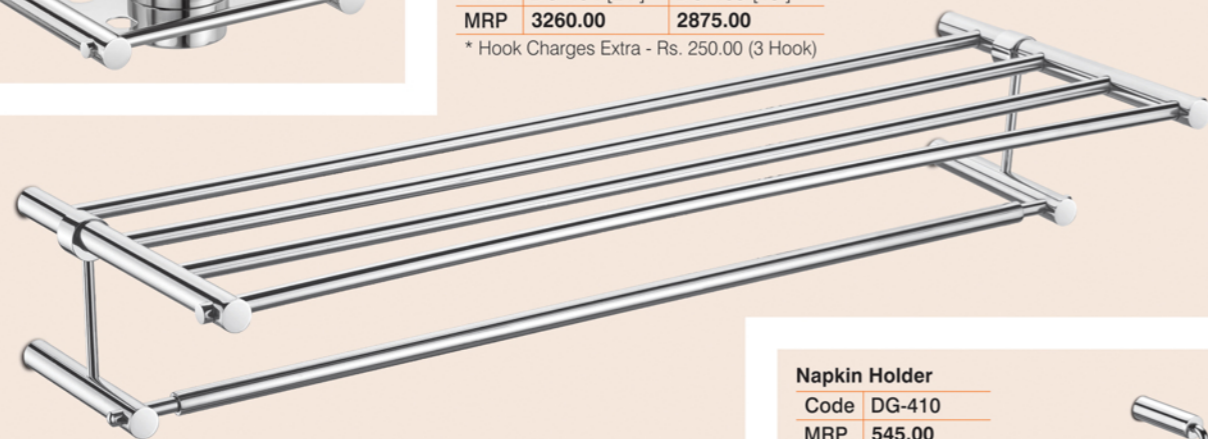

Napkin Holder

Code DG-410
MRP 545.00

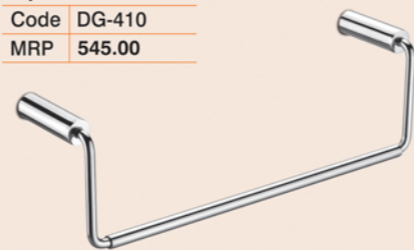

Soap Dish

Code DG-408
MRP 805.00



5 Pcs. Set

Code DG-401
MRP 3445.00

Towel Rod - Soap Dish
Toothbrush Tumbler
Napkin Holder - Robe Hook

Double Soap Dish

Code DG-415
MRP 1345.00

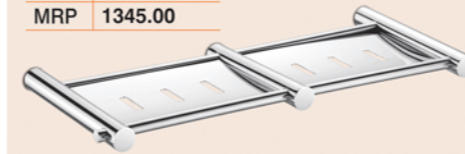

Robe Hook

Code DG-411
MRP 335.00



Soap Dish & Toothbrush Tumbler

Code DG-417
MRP 1560.00

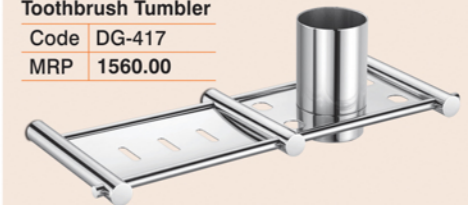

Towel Rod

Code DG-406 [24"] DG-407 [18"]
MRP 755.00 670.00

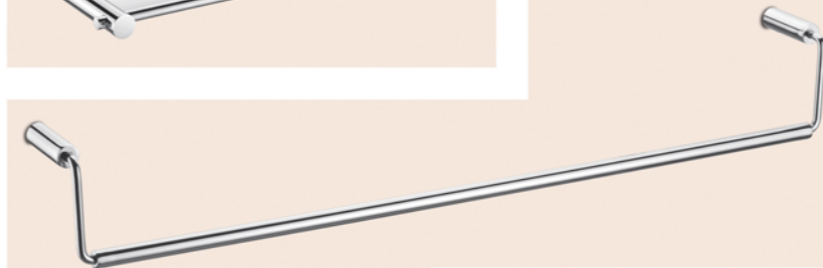

Paper Holder

Code DG-414
MRP 1075.00

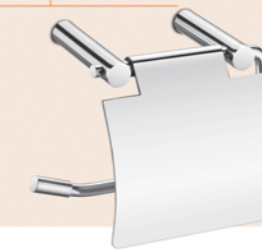

Toothbrush Tumbler & Napkin Holder

Code DG-418
MRP 1345.00



Liquid Soap Dispenser

Code DG-413
MRP 1140.00



Soap Dish & Napkin Holder

Code DG-419
MRP 1075.00

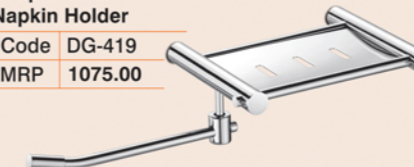

Liquid & Napkin Holder

Code DG-420
MRP 1595.00



Three in One

Code DG-421
MRP 2690.00

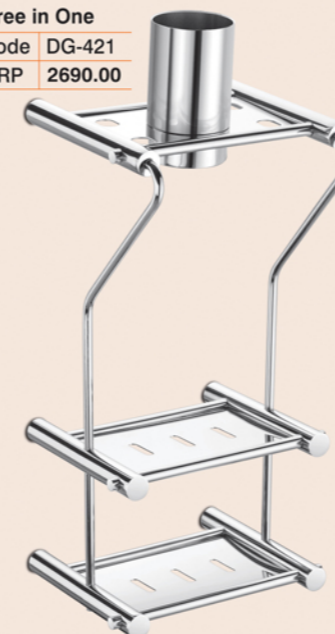

Four in One

Code DG-422
MRP 2855.00





GLOSSY FINISH



Curvy expressions of an elite lifestyle, this one best describes our design motto to deliver a dazzling excellence every day.

Towel Rack with Rod

Code	DG-604 [24"]	DG-605 [18"]
MRP	2820.00	2435.00

* Hook Charges Extra - Rs. 250.00 (3 Hook)

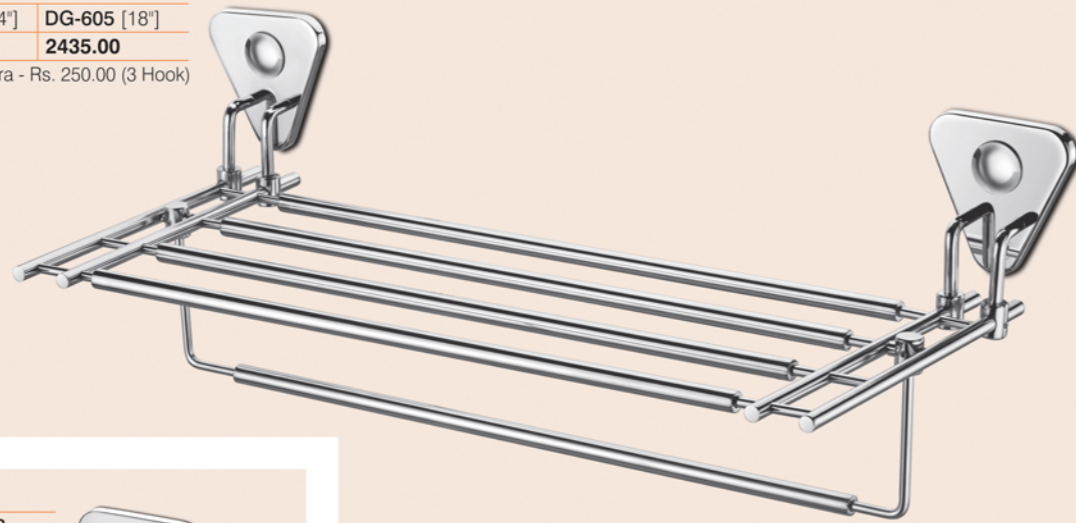

Soap Dish

Code	DG-608
MRP	370.00



Napkin Holder

Code	DG-610
MRP	505.00

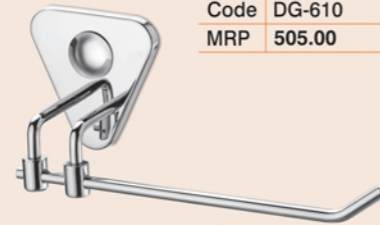

5 Pcs. Set

Code	DG-601
MRP	2990.00

- Towel Rod
- Soap Dish
- Toothbrush Tumbler
- Napkin Holder
- Robe Hook

Robe Hook

Code	DG-611
MRP	370.00



Towel Rod

Code	DG-606 [24"]	DG-607 [18"]
MRP	1040.00	940.00



Toothbrush Tumbler

Code	DG-609
MRP	705.00



Liquid Dispenser

Code	DG-613
MRP	790.00



Paper Holder

Code	DG-614
MRP	655.00

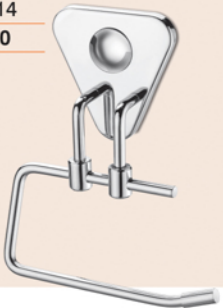

Double Soap Dish

Code	DG-615
MRP	1040.00

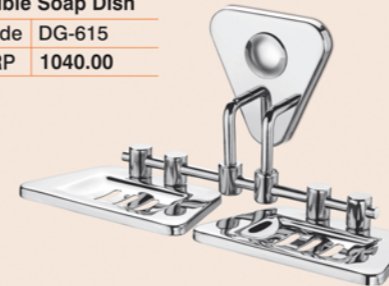

Soap Dish & Toothbrush Tumbler

Code	DG-617
MRP	1380.00



Soap Dish & Napkin Holder

Code	DG-619
MRP	840.00

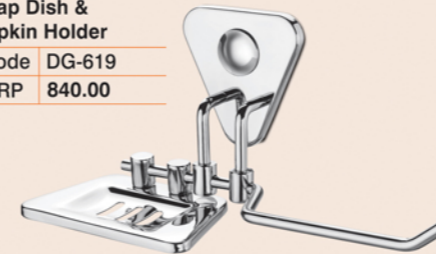

Liquid & Napkin Holder

Code	DG-620
MRP	1225.00



Toothbrush Tumbler & Napkin Holder

Code	DG-618
MRP	1160.00





GLOSSY FINISH



Ornament of a different kind that is specially crafted for your personal space to signify your distinguished urban lifestyle.

Towel Rack with Rod

Code	DG-704 [24"]	DG-705 [18"]
MRP	2690.00	2400.00

* Hook Charges Extra - Rs. 250.00 (3 Hook)

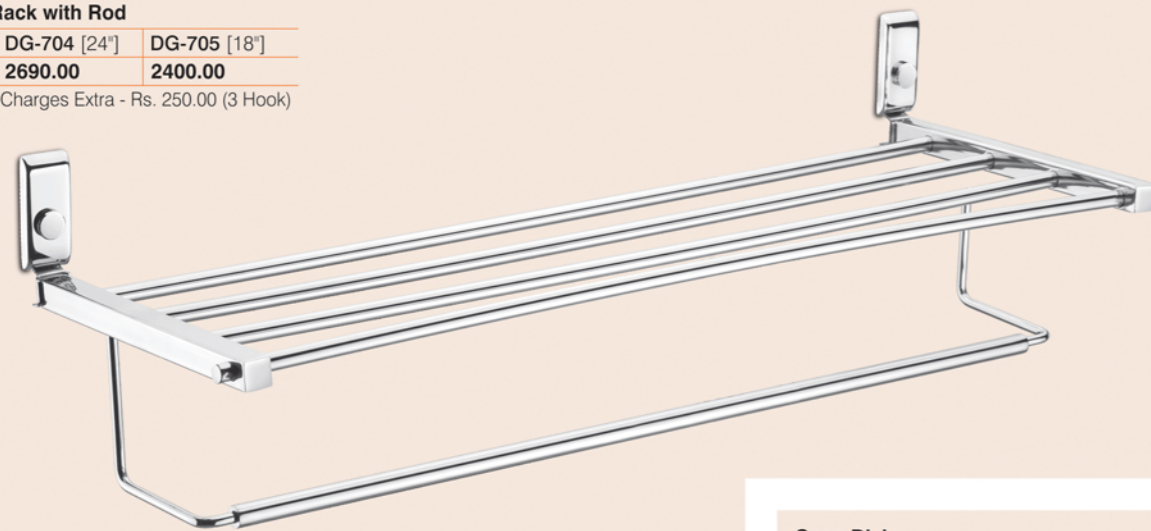

5 Pcs. Set

Code	DG-701
MRP	2690.00

- Towel Rod
- Soap Dish
- Toothbrush Tumbler
- Napkin Holder
- Robe Hook

Napkin Holder

Code	DG-710
MRP	470.00

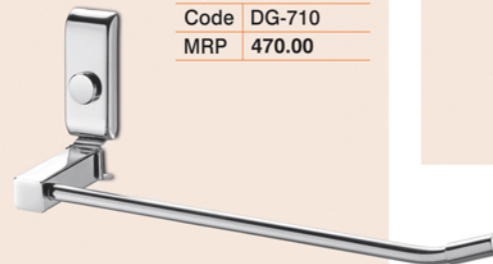

Soap Dish

Code	DG-708
MRP	335.00



Towel Rod

Code	DG-706 [24"]	DG-707 [18"]
MRP	990.00	940.00

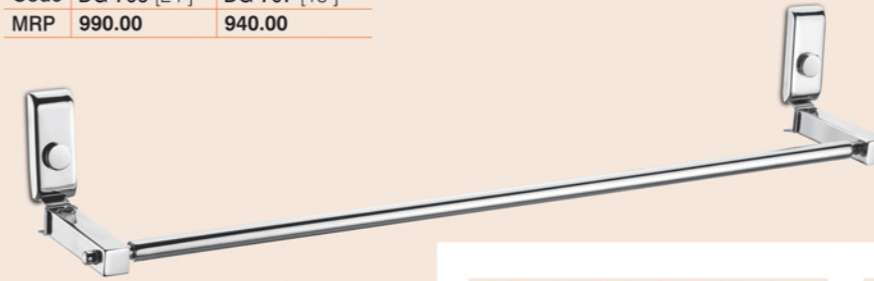

Robe Hook

Code	DG-711
MRP	300.00



Paper Holder

Code	DG-714
MRP	960.00



Liquid Soap Dispenser

Code	DG-713
MRP	740.00



Toothbrush Tumbler

Code	DG-709
MRP	590.00



Toothbrush Tumbler & Napkin Holder

Code	DG-718
MRP	990.00



Double Soap Dish

Code	DG-715
MRP	640.00



Liquid & Napkin Holder

Code	DG-720
MRP	1110.00



Soap Dish & Toothbrush Tumbler

Code	DG-717
MRP	840.00



Soap Dish & Napkin Holder

Code	DG-719
MRP	740.00



AISI 304 STAINLESS STEEL



GLOSSY FINISH



rub out all day's stress in the evening or get ready for the challenging schedule in morning with this mood elevator.

Towel Rack with Rod

Code	DG-904 [24"]	DG-905 [18"]
MRP	2820.00	2555.00

* Hook Charges Extra - Rs. 250.00 (3 Hook)

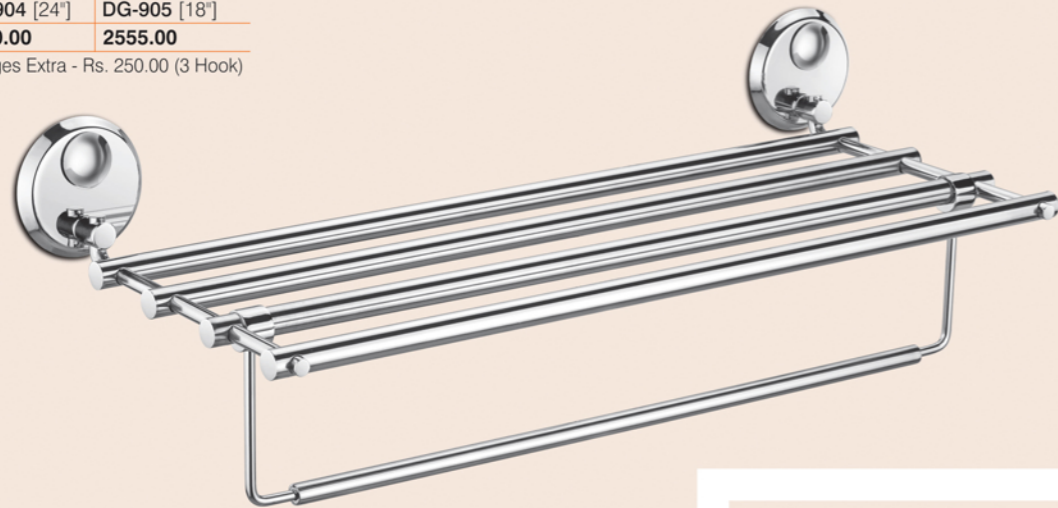

5 Pcs. Set

Code	DG-901
MRP	2940.00

Towel Rod
Soap Dish
Toothbrush Tumbler
Napkin Holder
Robe Hook

Soap Dish

Code	DG-908
MRP	420.00



Napkin Holder

Code	DG-910
MRP	605.00

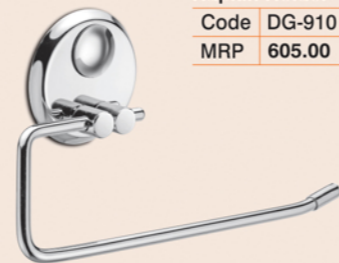

Liquid Soap Dispenser

Code	DG-913
MRP	825.00

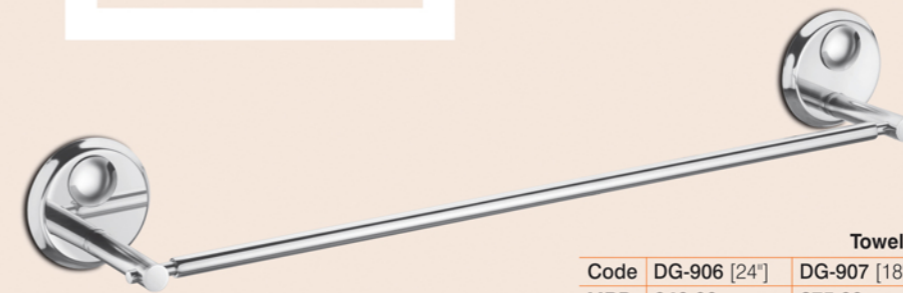

Towel Rod

Code	DG-906 [24"]	DG-907 [18"]
MRP	940.00	875.00

Robe Hook

Code	DG-911
MRP	270.00



Double Soap Dish

Code	DG-915
MRP	905.00



Toothbrush Tumbler

Code	DG-909
MRP	705.00



Soap Dish & Toothbrush Tumbler

Code	DG-917
MRP	1210.00



Paper Holder

Code	DG-914
MRP	940.00



AISI 304 STAINLESS STEEL

S S Shelf with Napkin Holder & Toothbrush Tumbler

Size	12" x 5"	15" x 5"	18" x 5"
MRP	1880.00	2085.00	2285.00



GLOSSY FINISH

s.s. 304 shelf

S S Double Shelf

Size	12" x 5"	15" x 5"	18" x 5"
MRP	2520.00	2955.00	3360.00

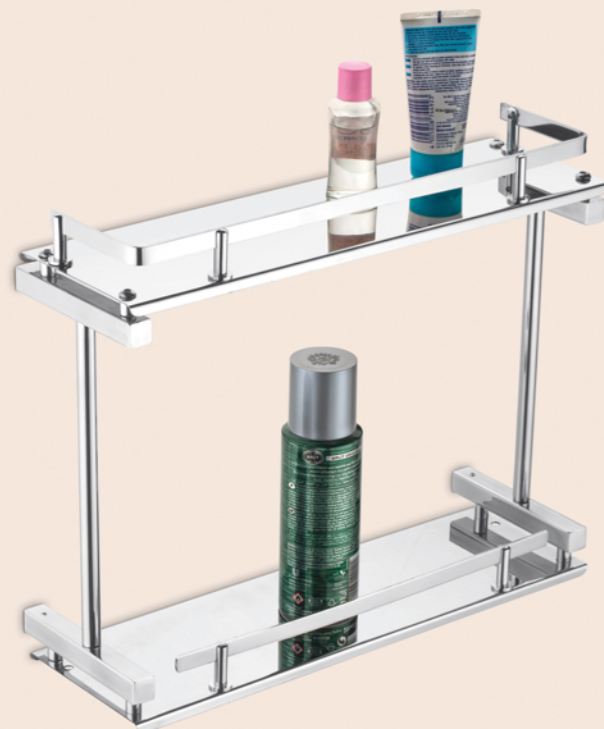

S S Double Shelf with Toothbrush Tumbler

Size	12" x 5"	15" x 5"	18" x 5"
MRP	2790.00	3190.00	3630.00

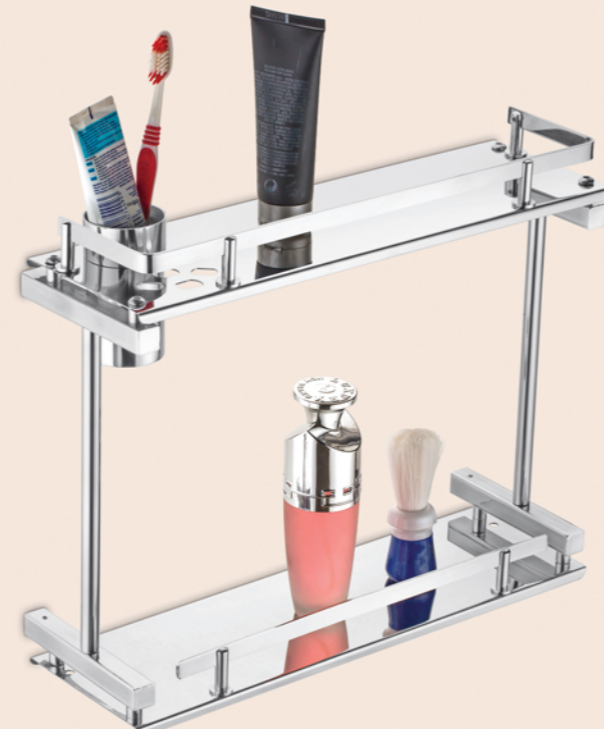

S S Shelf & Napkin Holder

Size	12" x 5"	15" x 5"	18" x 5"
MRP	1615.00	1815.00	2015.00

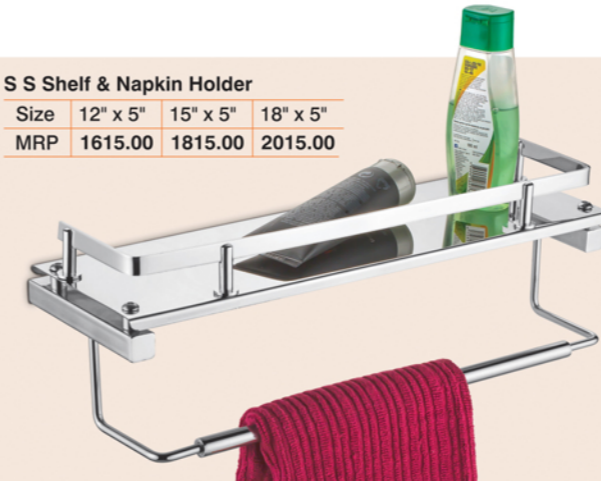

S S Shelf - Regular

Size	12" x 5"	15" x 5"	18" x 5"
MRP	1380.00	1510.00	1680.00

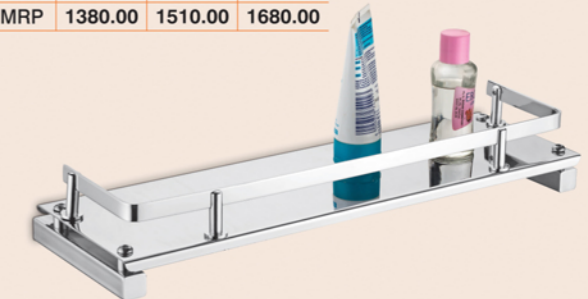

Glass Shelf (Frosted Toughened)

Size	12" x 6"	14" x 7"	16" x 7"
MRP	985.00	1155.00	1190.00

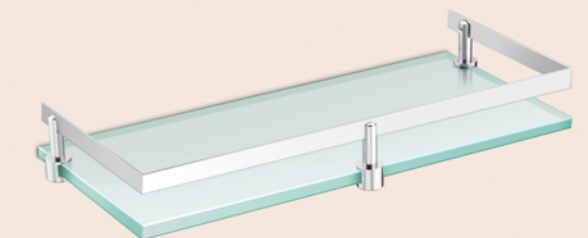

S S Shelf with Toothbrush Tumbler

Size	12" x 5"	15" x 5"	18" x 5"
MRP	1645.00	1780.00	1950.00

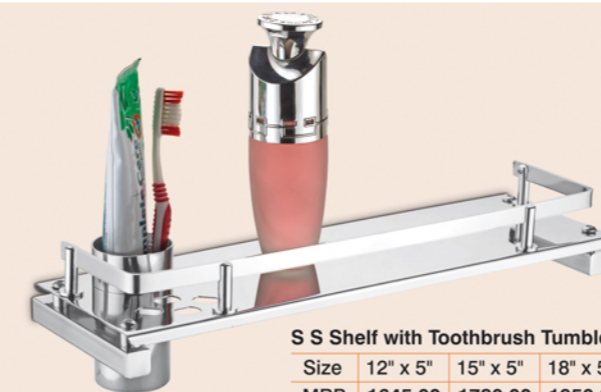

S.S. 304 Corner

Size	9" x 9"	12" x 12"
MRP	1295.00	1630.00



Glass Corner - Diamond (Frosted Toughened)

Size	9" x 9"	12" x 12"
MRP	1070.00	1255.00



Glass Corner - Round (Frosted Toughened)

Size	9" x 9"	12" x 12"
MRP	1070.00	1255.00



STAINLESS STEEL 202

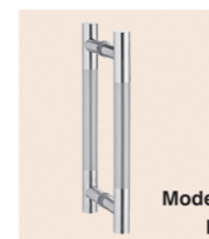

Model H

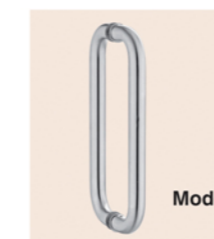

Model O



GRAB RAIL

Code	Satin MRP
H 2208	875.00
H 2210	965.00
H 2212	1060.00
H 2518	1645.00

Code	Satin MRP
O 2208	790.00
O 2210	890.00
O 2212	990.00
O 2518	1470.00

Code	Glossy MRP	Satin MRP
GR 2208	570.00	505.00
GR 2210	612.00	550.00
GR 2212	655.00	597.00



Cloth Rack
Size 5 Feet 6.5 Feet
MRP 6050.00 6720.00

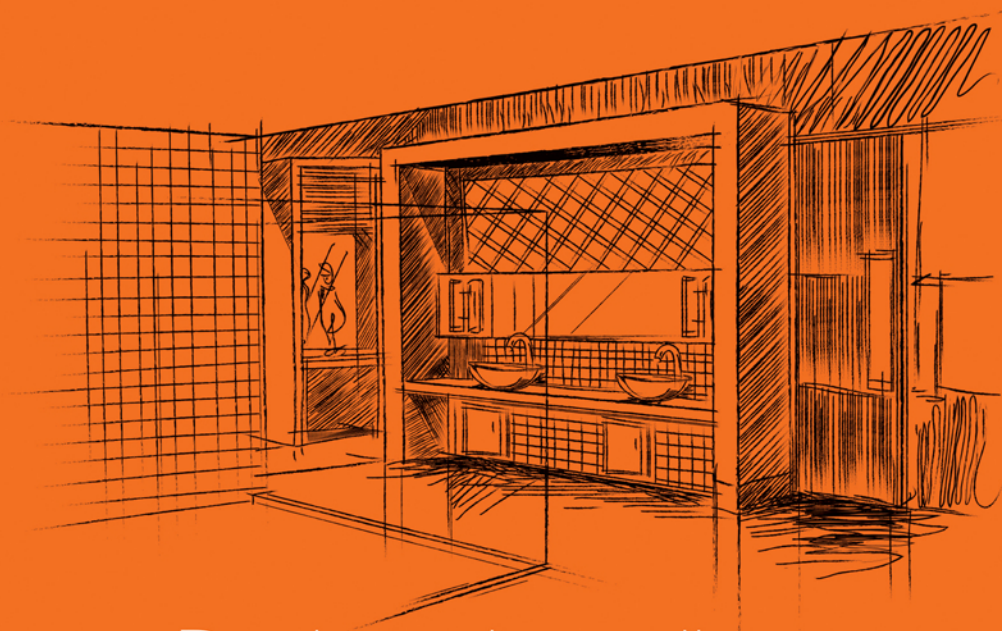

Designed excellence.



Manufacture By :

perdiem
INDUSTRIES

Mfg. Bathroom Accessories

Plot No. G-2528, H-1 Road,
Allmighty Gate,
G.I.D.C. METODA-360 021
Dist.: Rajkot (Gujarat) INDIA

✉ contact@dazzlebath.com
🌐 dazzlebath.com



SCAN this QR-code via QR-code reader
from your smart phone to know more.